

ViewSonic®

***VG700
VG700b***

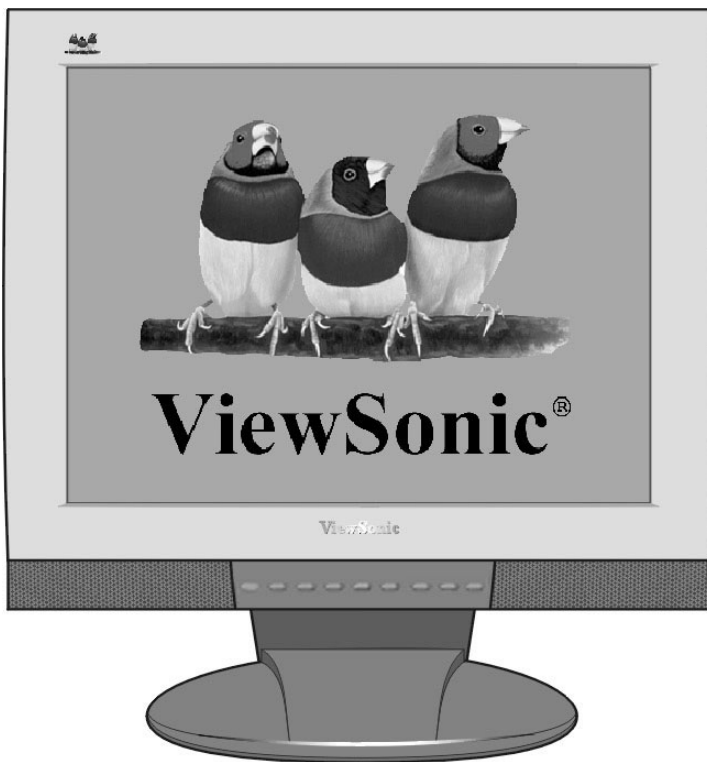

Full 17.0" Diagonal Viewable Screen

LCD Display

User Guide

Guide de l'utilisateur

Bedienungsanleitung

Guía del usuario

Guida dell'utente

Guia do usuário

Användarhandbok

Käyttöopas

Руководство пользователя

Instrukcja obsługi

ユーザーズ ガイド

使用手冊

使用手冊

사용자 안내서

دليل المستخدم

Contents

Product Registration.....	2
For Your Records.....	2

Getting Started

Package Contents.....	3
Precautions	3
Quick Installation.....	4
Installation of Wall Mount (Optional)	5

Using the LCD Display

Setting the Timing Mode	6
OSD and Power Button Lock Modes	6
Adjusting the Screen Image	7
Main Menu Controls	9

Other Information

Specifications	12
Troubleshooting	13
Customer Support.....	14
Cleaning the LCD Display	15
Limited Warranty	16

Appendix

Safety Guidelines.....	17
Compliance Information for U.S.A.....	18
CE Conformity for Europe	18

Copyright © ViewSonic Corporation, 2002. All rights reserved.

Macintosh and Power Macintosh are registered trademarks of Apple Computer, Inc.

Microsoft, Windows, Windows NT, and the Windows logo are registered trademarks of Microsoft Corporation in the United States and other countries.

ViewSonic, the three birds logo, OnView, ViewMatch, and ViewMeter are registered trademarks of ViewSonic Corporation.

VESA is a registered trademark of the Video Electronics Standards Association. DPMS and DDC are trademarks of VESA.

ENERGY STAR® is a registered trademark of the U.S. Environmental Protection Agency (EPA).

As an ENERGY STAR® partner, ViewSonic Corporation has determined that this product meets the ENERGY STAR® guidelines for energy efficiency.

Disclaimer: ViewSonic Corporation shall not be liable for technical or editorial errors or omissions contained herein; nor for incidental or consequential damages resulting from furnishing this material, or the performance or use of this product.

In the interest of continuing product improvement, ViewSonic Corporation reserves the right to change product specifications without notice. Information in this document may change without notice.

No part of this document may be copied, reproduced, or transmitted by any means, for any purpose without prior written permission from ViewSonic Corporation.

Product Registration

To meet your future needs, and to receive any additional product information as it becomes available, please register your product on the Internet at: www.viewsonic.com. The ViewSonic Wizard CD-ROM also provides an opportunity for you to print the registration form, which you may mail or fax to ViewSonic.

For Your Records

Product Name:	ViewSonic VG700/VG700b
Model Number:	VLCDS23719-1W/3W
Document Number:	A-CD-VG700-1/A-CD-VG700b-1
Serial Number:	_____
Purchase Date:	_____

Product disposal at end of product life

ViewSonic is concerned about the preservation of our environment. Please dispose of this product properly at the end of its useful life. Your local waste disposal company may provide information about proper disposal.

Getting Started

Congratulations on your purchase of a ViewSonic® LCD display.

Important! Save the original box and all packing material for future shipping needs.

NOTE: The word “Windows” refers to Microsoft Windows 95, 98, NT, XP, 2000 and Me (Millennium).

Package Contents

IMPORTANT: Save all packing material.

Your LCD display package includes:

- LCD display
- Power cords
- Audio cable
- Video cable (VGA)
- AC/DC Adapter
- ViewSonic Wizard CD-ROM

NOTE: The CD jacket contains the Quick Start Guide, and the CD includes User Guide PDF files and INF/ICM display optimization files. The INF files ensures compatibility with Windows operating systems, and the ICM file (Image Color Matching) ensures accurate on-screen colors. ViewSonic recommends that you install both files.

Precautions

-
- Sit at least 18" from your LCD display display.
 - **Avoid touching the screen.** Skin oils are difficult to remove.
 - **Never remove the rear cover.** Your LCD display contains high-voltage parts. You may be seriously injured if you touch them.
 - Avoid exposing your LCD display to direct sunlight or another heat source. Orient your LCD display away from direct sunlight to reduce glare.
 - Always handle your LCD display with care when moving it.
 - Place your LCD display in a well-ventilated area. Do not place anything on your LCD display that prevents heat dissipation.
 - Ensure the area around the LCD display is clean and free of moisture.
 - Do not place heavy objects on the LCD display, video cable, or power cord.
 - If smoke, abnormal noise, or strange odor is present, immediately switch the LCD display off and call your dealer or ViewSonic. It is dangerous to continue using the LCD display.
-

Quick Installation

Optional: For instructions on wall mounting, see page 5 of this user guide.

1 Connect power cord and AC/DC adapter

2 Connect video cable

- Make sure both the LCD display and computer are turned OFF
- Connect the video cable from the LCD display to the computer

Macintosh users: Models older than G3 require a Macintosh adapter. Attach the adapter to the computer and plug the video cable into the adapter.

To order a ViewSonic Macintosh adapter, contact ViewSonic Customer Support.

3 Turn ON LCD display and computer

- Turn ON the LCD display, then turn ON the computer. This sequence (LCD display before computer) is important.

NOTE: Windows 95, 98 or 2000 users may receive a message asking them to install the INF file. This is on the CD.

4 Insert the ViewSonic Wizard CD into the computer's CD drive

- Follow the on-screen instructions

If your computer does not have a CD-ROM drive, see Customer Support.

- (1) Wait for the CD-ROM to auto-start.

NOTE: If the CD-ROM does not auto-start: double-click on the CD-ROM icon in the Windows Explorer, then double-click on **viewsonic.exe**.

- (2) Follow the on-screen instructions.

5 Windows users: Set the timing mode (resolution and refresh rate)

Example: 1280 X 1024 @ 60 Hz.

For instructions on changing the resolution and refresh rate, see the graphic card's user guide.

Installation is complete. Enjoy your new ViewSonic LCD display.

To be best prepared for any future customer service needs: print this user guide and write the serial number in *or Your Records* on page 2. (See back of LCD display.)

You can register your product online at the website for your region. See the Customer Support table in this guide.

The ViewSonic Wizard CD-ROM also provides an opportunity for you to print the registration form which you may mail or fax to ViewSonic.

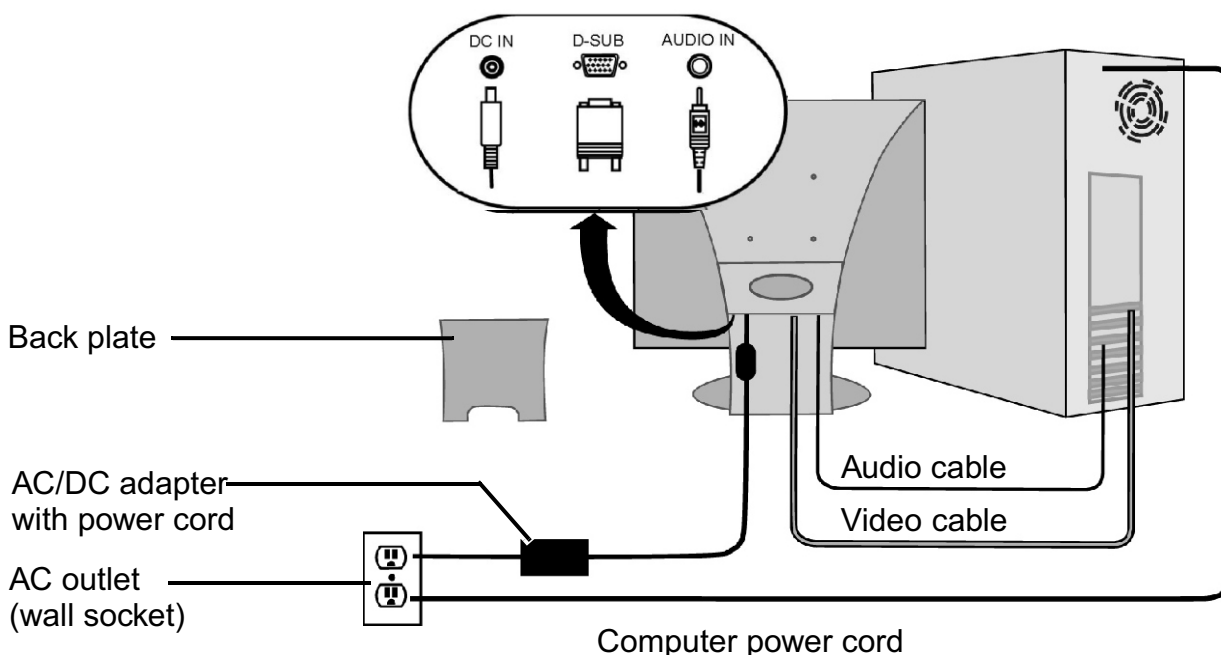

Installation of Wall Mount (Optional)

To obtain a wall-mounting kit, contact ViewSonic or your local dealer. Refer to the instructions that come with the base mounting kit. To convert your LCD display from a desk-mounted to a wall-mounted display, do the following:

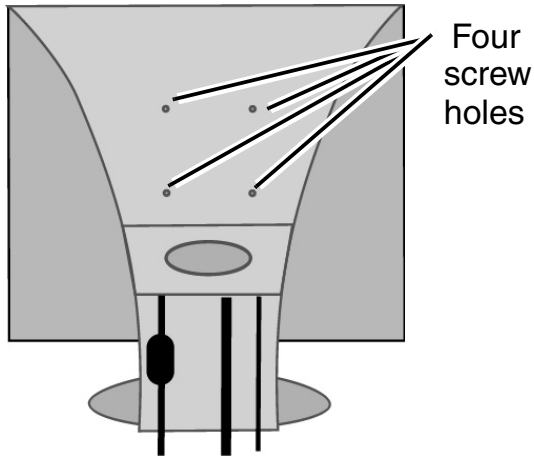

- 1** Disconnect Power.
- 2** Lay the LCD display face down on a towel or blanket. Notice the four screw holes on the bottom of the base for the wall mount.
- 3** Attach the mounting bracket from the VESA compatible wall-mounting kit (100 mm x 100 mm distance).
- 4** Attach the LCD display to the wall, following the instructions in the wall-mounting kit.

Using the LCD Display

Setting the Timing Mode

Setting the timing mode is important for maximizing the quality of the screen image and minimizing eye strain. The **timing mode** consists of the **resolution** (example 1280 x 1024) and **refresh rate** (or vertical frequency; example 60 Hz). After setting the timing mode, use the OnView® controls to adjust the screen image.

For the best picture quality set your LCD display timing mode to:
VESA 1280 x 1024 @ 60 Hz.

To set the Timing Mode:

- 1 Set the resolution: Right-click on the Windows desktop > **Properties** > **Settings** > set the resolution.
- 2 Set the refresh rate: See your graphic card's user guide for instructions.

WARNING: Do not set the graphics card in your computer to exceed the maximum refresh rate of 75 Hz; doing so may result in permanent damage to your LCD display.

OSD and Power Button Lock Modes

OSD Lock: This mode locks all current control settings and prevents access to the control menus until this mode is unlocked.

- **OSD Lock:** Press and hold [1] and the up arrow ▲ for 10 seconds. If any buttons are pressed the message *OSD Locked* will display for 5 seconds.
- **OSD Unlock:** Press and hold [1] and the up arrow ▲ again for 10 seconds.

Power Button Lock: This mode locks the power of the LCD display in the ON position.

- **Power Button Lock:** Press and hold [1] and the down arrow ▼ for 10 seconds. If the power button is pressed the message *Power Button Locked* will display for 5 seconds. With or without this setting, after a power failure, your LCD display's power will automatically turn ON when power is restored.
- **Power Button Unlock:** Press and hold [1] and the down arrow ▼ again for 10 seconds.

Adjusting the Screen Image

Use the buttons on the front control panel to display and adjust the OnView® controls which display on the screen. The OnView controls are explained at the top of the next page and are defined in “Main Menu Controls” on page 9.

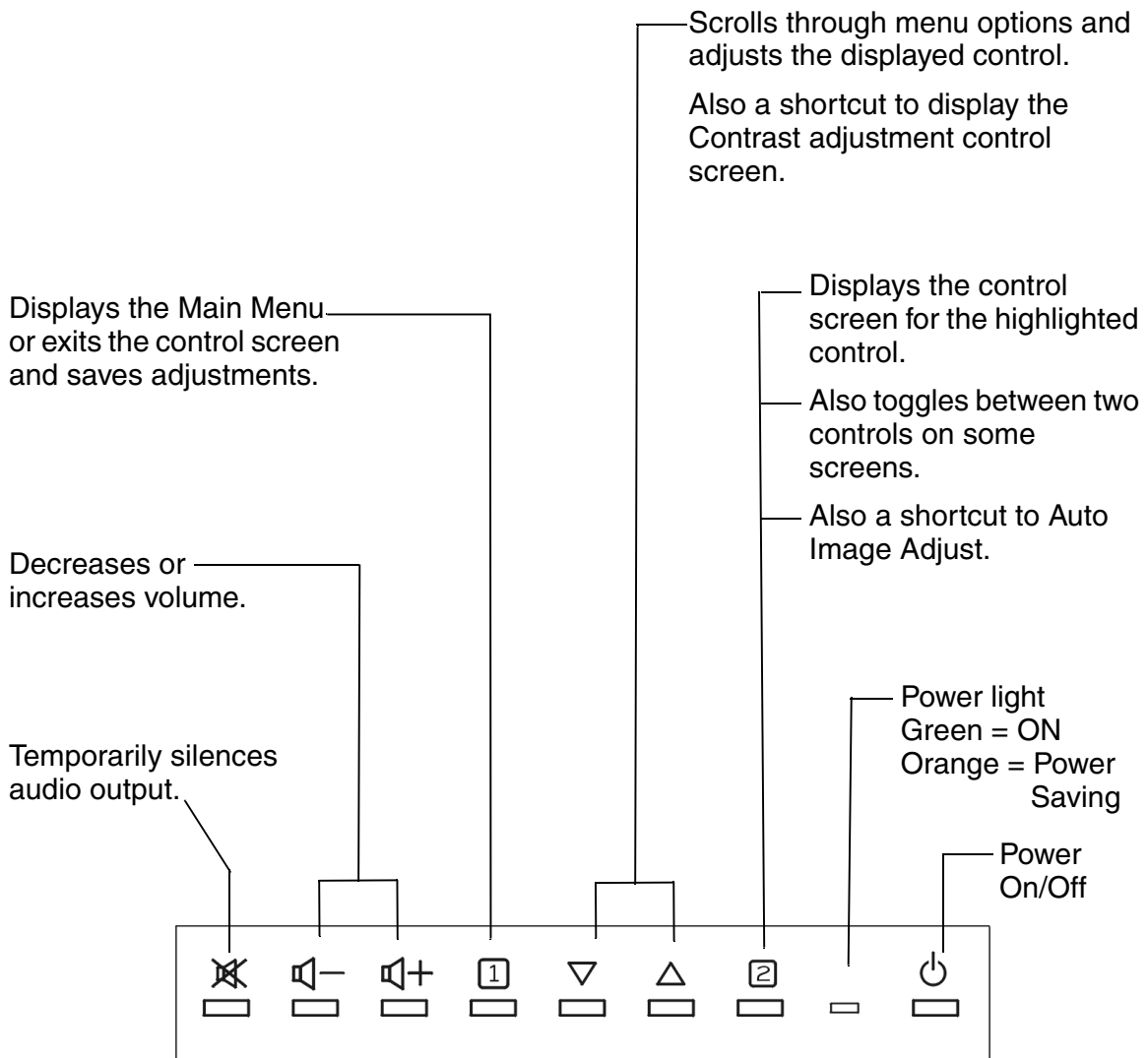
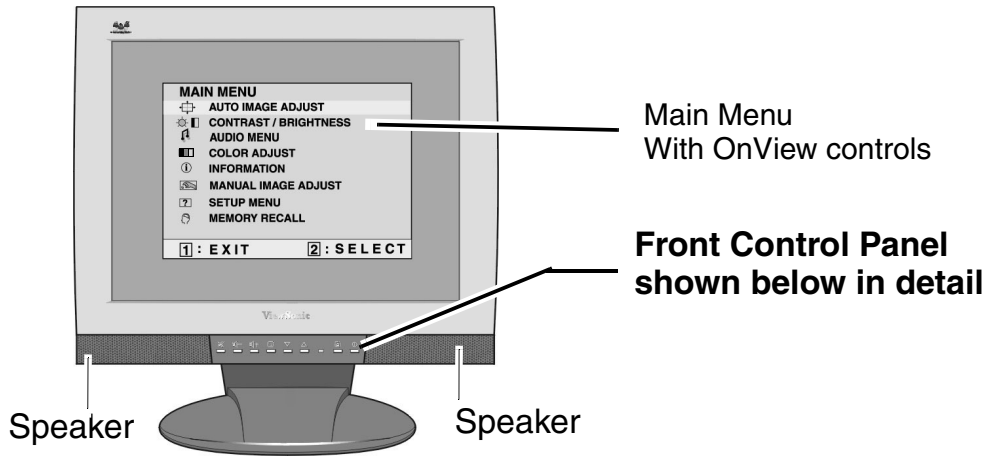

Do the following to adjust the screen image:

- 1 To display the Main Menu, press button [1].

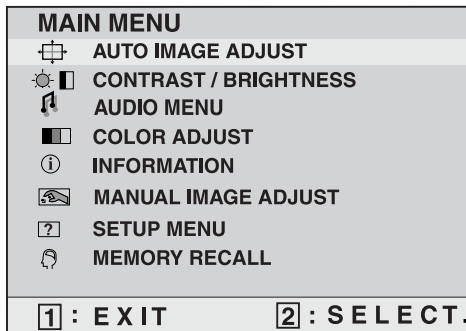

The line at the bottom of the screen tells you what you can do next: Exit this menu or Select the control that is highlighted.

NOTE: All OnView menus and adjustment screens disappear automatically after about 30 seconds. This time period is adjustable through the Setup menu and the OSD timeout control described on page 10.

- 2 To highlight a control you want to adjust, press ▲ or ▼ to scroll up or down the Main Menu.
- 3 To select the highlighted control, press button [2]. A control screen appears.
- 4 To adjust the control, press the up ▲ or down ▼ buttons.
- 5 To save the adjustments and exit the menu, press button [1] *twice*.

The following tips may help you optimize your display:

- Adjust your computer's graphic card so that it outputs a video signal 1280 x 1024 @ 60 Hz to the LCD display. (Look for instructions on “changing the refresh rate” in your graphic card's user guide.)
- If necessary, make small adjustments using H POSITION and V POSITION until the screen image is completely visible. (The black border around the edge of the screen should barely touch the illuminated “active area” of the LCD display.)

Main Menu Controls

Adjust the menu items shown below by using the up ▲ and down ▼ buttons.

Control	Explanation
---------	-------------



Auto Image Adjust automatically sizes, centers, and fine tunes the video signal to eliminate waviness and distortion. Press the [2] button to obtain a sharper image.

NOTE: Auto Image Adjust works with most common video cards. If this function does not work on your LCD display, then lower the video refresh rate to 60 Hz and set the resolution to its pre-set value.

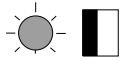

Contrast adjusts the difference between the image background (black level) and the foreground (white level).

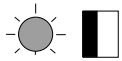

Brightness adjusts background black level of the screen image.



Audio Menu controls are explained below:

Volume increases the volume, decreases the volume, and mutes the audio.

Mute temporarily silences audio output.



Color Adjust provides several color options: preset color temperatures and Custom User Color which allows you to adjust red (R), green (G), and blue (B). The factory setting for this product is 6500K (6500° Kelvin).

9300K — Adds blue to the screen image for cooler white (used in most office settings with fluorescent lighting).

6500K — Adds red to the screen image for warmer white and richer red.

5400K — Adds green to the screen image for a darker color.

5000K — Adds blue and green to the screen image for a darker color.

Custom User Color — Individual adjustments for red, green, and blue.

- 1 To select color (R, G or B) press button [2].
- 2 To adjust selected color, press ▲ or ▼.
- 3 When you are finished making all color adjustments, press button [1] *twice*.

Control Explanation



Information displays the timing mode (video signal input) coming from the graphics card in your computer. See your graphic card's user guide for instructions on changing the resolution and refresh rate (vertical frequency).

VESA 1280 x 1024 @ 60 Hz (recommended) means that the resolution is 1280 x 1024 and the refresh rate is 60 Hertz.



Manual Image Adjust controls are explained below:

H. Size (Horizontal Size) adjusts the width of the screen image.

NOTE: Vertical size is automatic with your LCD display.

H./V. Position adjusts horizontal and vertical position of the screen image. You can toggle between Horizontal and Vertical by pressing button [2]. Horizontal moves the screen image to the left or to the right. Vertical moves the screen image up and down.

Fine Tune sharpens focus by aligning the illuminated text and/or graphic characters.

NOTE: Try the **Auto Image Adjust** (see page 9) before using the **Fine Tune** control.

Sharpness adjusts the clarity and focus of the screen image.



Setup Menu controls are explained below:

Language allows you to choose the language used in the menus and control screens.

Resolution Notice displays the recommended resolution for this LCD display.

Enable allows the Resolution Notice to appear on-screen.

Disable will not allow the Resolution Notice to appear on-screen.

OSD Position allows you to move the on-screen display menus and control screens.

Control	Explanation
----------------	--------------------

OSD Timeout sets the length of time an on-screen display screen is displayed. For example, with a “15 second” setting, if a control is not pushed within 15 seconds, the display screen disappears.

OSD Background allows you to turn the On-Screen Display background On or Off.



Memory Recall returns adjustments to the original factory settings if the display is operating in a factory Preset Timing Mode listed in this user guide.

Exception: This control does not effect changes made with the Custom User Color control.

Other Information

Specifications

LCD	Type	17" (full 17" viewable diagonal area), TFT (Thin Film Transistor), Active Matrix SXGA LCD, 0.264 mm pixel pitch	
	Color Filter Glass surface	RGB vertical stripe Anti-Glare	
Input signal	Video Sync	RGB analog (0.7/1.0 Vp-p, 75 ohms) Separate Sync f_h :30-82 kHz, f_v :50-85 Hz	
Compatibility	PC Macintosh ¹	Up to 1280 x 1024 Non-interlaced Power Macintosh up to 1280 x 1024	
Resolution	Recommended and supported	1280 x 1024 @ 60, 75 1024 x 768 @ 60, 70, 75, 85 Hz 800 x 600 @ 56, 60, 75, 85 Hz 640 x 480 @ 60, 75, 85 Hz 640 x 400 @ 70 Hz 720 x 400 @ 70 Hz	
Power	Voltage	100-240 VAC, 50/60 Hz (auto switch), 12V DC, 3A	
Display area	Full Scan	337.92 mm (H) x 270.34 mm (V) 13.3" (H) x 10.64" (V)	
Operating conditions	Temperature Humidity Altitude	+32° F to +104° F (0° C to +40° C) 10% to 90% (no condensation) To 10,000 feet	
Storage conditions	Temperature Humidity Altitude	-4° F to +140° F (-20° C to +60° C) 10% to 90% (no condensation) To 40,000 feet	
Dimensions	Physical	410.00 mm (W) x 421.40 mm (H) x 191.22 mm (D) 16.17" (W) x 16.59" (H) x 7.56" (D)	
Weight	Net	5.3 kg (11.6 lbs)	
Regulations		UL, FCC-B, ENERGY STAR®, IC-B (Doc-B), CE, MPRII, NEMKO, SEMKO, DEMKO, FIMKO, C-UL, TCO'99 (VG700), TCO'95 (VG700b), TUV-S, EPA, VCCI, BSMI, CB, ISO13406-2, Gost-R, PCT (BZ02)	
Power saving modes	On Active Off	Normal < 3W	(green LED) (orange LED)

Preset Timing Mode (pre-adjusted to VESA® 1280 x 1024 @ 60 Hz)

Warning: Do not set the graphics card in your computer to exceed these refresh rates; doing so may result in permanent damage to the LCD display.

¹ Macintosh computers older than G3 require a ViewSonic®, Macintosh adapter. To order an adapter, contact ViewSonic.

Troubleshooting

No power

- Make sure power button (or switch) is ON.
- Make sure A/C power cord is securely connected to the DC power supply and the power supply is firmly connected to the LCD display.
- Plug another electrical device (like a radio) into the power outlet to verify that the outlet is supplying proper voltage.

Power is ON but no screen image

- Make sure the video cable supplied with the LCD display is tightly secured to the video output port on the back of the computer. If the other end of the video cable is not attached permanently to the LCD display, tightly secure it to the LCD display.
- Adjust brightness and contrast.
- If you are using an Macintosh older than G3, you need a Macintosh adapter.

Wrong or abnormal colors

- If any colors (red, green, or blue) are missing, check the video cable to make sure it is securely connected. Loose or broken pins in the cable connector could cause an improper connection.
- Connect the LCD display to another computer.
- If you have an older graphics card, contact ViewSonic® for a non-DDC adapter.

Control buttons do not work

- Press only one button at a time.

Customer Support

For technical support or product service, see the table below or contact your reseller.

NOTE: You will need the product serial number.

Country/ Region	Web site	T = Telephone F = FAX	Email
United States	viewsonic.com/ support	T: (800) 688-6688 F: (909) 468-1202	service.us@ viewsonic.com
Canada	viewsonic.com/ support	T: (800) 688-6688 F: (909) 468-1202	service.ca@ viewsonic.com
United Kingdom	viewsoniceurope.com	T: 0800 833 648 F: (01293) 643910	service.eu@ viewsoniceurope.com
Europe, Middle East, Baltic countries, and North Africa	viewsoniceurope.com	Contact your reseller	service.eu@ viewsoniceurope.com
Australia and New Zealand	viewsonic.com.au	T: +61 2 9929 3955 F: +61 2 9929 8393	service.au@ viewsonic.com
Singapore/India and Southeast Asia	viewsonic.com.sg	T: 65 273 4018 F: 65 273 1566	service.sg@ viewsonic.com
Other Asia/Pacific countries	viewsonic.com.tw	T: 886 2 2246 3456 F: 886 2 8242 3668	service.ap@ viewsonic.com
South Africa	viewsonic.com/asia	T: 886 2 2246 3456 F: 886 2 8242 3668	service.ap@ viewsonic.com

Cleaning the LCD Display

- MAKE SURE THE LCD DISPLAY IS TURNED OFF.
- NEVER SPRAY OR POUR ANY LIQUID DIRECTLY ONTO THE SCREEN OR CASE.

To clean the screen:

- 1 Wipe the screen with a clean, soft, lint-free cloth. This removes dust and other particles.
- 2 If still not clean, apply a small amount of non-ammonia, non-alcohol based glass cleaner onto a clean, soft, lint-free cloth, and wipe the screen.

To clean the case:

- 1 Use a soft, dry cloth.
- 2 If still not clean, apply a small amount of a non-ammonia, non-alcohol based, mild non-abrasive detergent onto a clean, soft, lint-free cloth, then wipe the surface.

Disclaimer

ViewSonic® does not recommend the use of any ammonia or alcohol-based cleaners on the LCD display screen or case. Some chemical cleaners have been reported to damage the screen and/or case of the LCD display. ViewSonic will not be liable for damage resulting from use of any ammonia or alcohol-based cleaners.

Limited Warranty

VIEWSONIC LCD DISPLAY

What the warranty covers:

ViewSonic® warrants its products to be free from defects in material and workmanship during the warranty period. If a product proves to be defective in material or workmanship during the warranty period, **ViewSonic** will, at its sole option, repair or replace the product with a like product. Replacement product or parts may include remanufactured or refurbished parts or components.

How long the warranty is effective:

ViewSonic LCD displays are warranted for three (3) years for all parts including the light source and three (3) years for all labor from the date of the first consumer purchase.

Who the warranty protects:

This warranty is valid only for the first consumer purchaser.

What the warranty does not cover:

1. Any product on which the serial number has been defaced, modified or removed.
2. Damage, deterioration or malfunction resulting from:
 - a. Accident, misuse, neglect, fire, water, lightning, or other acts of nature, unauthorized product modification, or failure to follow instructions supplied with the product.
 - b. Repair or attempted repair by anyone not authorized by **ViewSonic**.
 - c. Any damage of the product due to shipment.
 - d. Removal or installation of the product.
 - e. Causes external to the product, such as electrical power fluctuations or failure.
 - f. Use of supplies or parts not meeting **ViewSonic's** specifications.
 - g. Normal wear and tear.
 - h. Any other cause which does not relate to a product defect.
3. Removal, installation, and set-up service charges.

How to get service:

1. For information about receiving service under warranty, contact **ViewSonic Customer Support**. You will need to provide your product's serial number.
2. To obtain service under warranty, you will be required to provide (a) the original dated sales slip, (b) your name, (c) your address, (d) a description of the problem, and (e) the serial number of the product.
3. Take or ship the product freight prepaid in the original container to an authorized **ViewSonic** service center or **ViewSonic**.
4. For additional information or the name of the nearest **ViewSonic** service center, contact **ViewSonic**.

Limitation of implied warranties:

THERE ARE NO WARRANTIES, EXPRESS OR IMPLIED, WHICH EXTEND BEYOND THE DESCRIPTION CONTAINED HEREIN INCLUDING THE IMPLIED WARRANTY OF MERCHANTABILITY AND FITNESS FOR A PARTICULAR PURPOSE.

Exclusion of damages:

VIEWSONIC'S LIABILITY IS LIMITED TO THE COST OF REPAIR OR REPLACEMENT OF THE PRODUCT. VIEWSONIC SHALL NOT BE LIABLE FOR:

1. DAMAGE TO OTHER PROPERTY CAUSED BY ANY DEFECTS IN THE PRODUCT, DAMAGES BASED UPON INCONVENIENCE, LOSS OF USE OF THE PRODUCT, LOSS OF TIME, LOSS OF PROFITS, LOSS OF BUSINESS OPPORTUNITY, LOSS OF GOODWILL, INTERFERENCE WITH BUSINESS RELATIONSHIPS, OR OTHER COMMERCIAL LOSS, EVEN IF ADVISED OF THE POSSIBILITY OF SUCH DAMAGES.
2. ANY OTHER DAMAGES, WHETHER INCIDENTAL, CONSEQUENTIAL OR OTHERWISE.
3. ANY CLAIM AGAINST THE CUSTOMER BY ANY OTHER PARTY.

Effect of state law:

This warranty gives you specific legal rights, and you may also have other rights which vary from state to state. Some states do not allow limitations on implied warranties and/or do not allow the exclusion of incidental or consequential damages, so the above limitations and exclusions may not apply to you.

Sales outside the U.S.A. and Canada:

For warranty information and service on **ViewSonic** products sold outside of the U.S.A. and Canada, contact **ViewSonic** or your local **ViewSonic** dealer.

ViewSonic LCD Display Warranty (V3.0)

Release Date: 1-29-2002

Appendix

Safety Guidelines

Warning: This device must be operated with the original power supply, part number: 12V DC, LSE0107A1240, 12V DC, SA125V-3.

CAUTION: The socket-outlet should be installed near the equipment and should be easily accessible.

CAUTION: Use a power cable that is properly grounded. Always use the appropriate AC cord that is certified for the individual country. Some examples are listed below:

USA..... UL	Switzerland SEV
Canada..... CSA	Britain BASE/BS
Germany VDE	Japan Electric Appliance Control Act

IMPORTANT NOTICE CONCERNING POWER CORD SELECTION

The power cord set for this unit has been enclosed and has been selected according to the country of destination and must be used to prevent electric shock. Use the following guidelines if it is necessary to replace the original cord set, or if the cord set is not enclosed.

The female receptacle of the cord set must meet IEC-60320 requirements and may look like (Figure A1 below):



For the United States and Canada

In the United States and Canada the male plug is a NEMA5-15 style (Figure A2), UL Listed, and CSA Labeled. For units which are mounted on a desk or table, type SVT or SJT cord sets may be used. For units which sit on the floor, only SJT type cord sets may be used. The cord set must be selected according to the current rating for your unit. Please consult the table below for the selection criteria for power cords used in the United States and Canada.

Cord Type	Size of Conductors in Cord	Maximum Current Rating of Unit
SJT	18 AWG	10 Amps
	16 AWG	12 Amps
	14 AWG	12 Amps
SVT	18 AWG	10 Amps
	17 AWG	12 Amps

For European Countries

In Europe you must use a cord set which is appropriate for the receptacles in your country. The cord set is HAR-Certified, and a special mark that will appear on the outer sheath, or on the insulation of one of the inner conductors.

AC PLUG CORD PRECAUTIONS FOR THE UNITED KINGDOM

FOR YOUR SAFETY PLEASE READ THE FOLLOWING TEXT CAREFULLY.

IF THE FITTED MOULDED PLUG IS UNSUITABLE FOR THE SOCKET OUTLET THEN THE PLUG SHOULD BE CUT OFF AND DISPOSED OF SAFELY.

THERE IS A DANGER OF SEVERE ELECTRICAL SHOCK IF THE CUT OFF PLUG IS INSERTED INTO AN APPROPRIATE SOCKET.

If a new plug is to be fitted, please observe the wiring code as shown below.

If in any doubt, please consult a qualified electrician.

WARNING: THIS APPLIANCE MUST BE EARTHED.

IMPORTANT: The wires in this mains lead are coloured in accordance with the following code:

Green-and-Yellow: Earth
Blue: Neutral
Brown: Live

If the coloured wires of the mains lead of this appliance do not correspond with the coloured markings identifying the terminals in your plug, proceed as follows:

The wire which is coloured GREEN-AND-YELLOW must be connected to the terminal in the plug which is marked by the letter E or by the Earth symbol or coloured GREEN or GREEN-AND-YELLOW.

The wire which is coloured BLUE must be connected to the terminal in the plug which is marked with the letter N or coloured BLACK. The wire which is coloured BROWN must be connected to the terminal in the plug which is marked with the letter L or coloured RED.

If you have any questions concerning which proper power cord to use, please consult with the dealer from whom you have purchased the product.

Compliance Information for U.S.A.

This equipment has been tested and found to comply with the limits for a Class B digital device, pursuant to part 15 of the FCC Rules. These limits are designed to provide reasonable protection against harmful interference in a residential installation. This equipment generates, uses, and can radiate radio frequency energy, and if not installed and used in accordance with the instructions, may cause harmful interference to radio communications. However, there is no guarantee that interference will not occur in a particular installation. If this equipment does cause harmful interference to radio or television reception, which can be determined by turning the equipment off and on, the user is encouraged to try to correct the interference by one or more of the following measures:

- Reorient or relocate the receiving antenna.
- Increase the separation between the equipment and receiver.
- Connect the equipment into an outlet on a circuit different from that to which the receiver is connected.
- Consult the dealer or an experienced radio/TV technician for help.

FCC Warning

To assure continued FCC compliance, the user must use grounded power supply cord and the provided shielded video interface cable with bonded ferrite cores. If a BNC cable is going to be used, use only a shielded BNC(5) cable. Also, any unauthorized changes or modifications not expressly approved by the party responsible for compliance could void the user's authority to operate this device.

Notice for Japan

This is a Class B product based on the standard of the Voluntary Control Council for Interference from Information Technology Equipment (VCCI). If this is used near a radio or television receiver in a domestic environment, it may cause radio interference. Install and use the equipment according to the instruction manual.

CE Conformity for Europe



The device complies with the requirements of the EEC directive 89/336/EEC as amended by 92/31/EEC and 93/68/EEC Art.5 with regard to "Electromagnetic compatibility", and 73/23/EEC as amended by 93/68/EEC Art.13 with regard to "Safety".

ViewSonic® Corporation